



SSUSA's Original Tournament of Champions 2019

Polk County, Florida

February 8 - 10, 2019

Rev. 01/17/2019

Men's 40+ Masters Division • 6 Teams

<u>Win</u>	<u>Loss</u>			<u>40-Platinum</u>			<u>Win</u>	<u>Loss</u>			<u>40-AAA</u>
2	1	1		Suncoast Adidas 40's (FL)			1	2	4		Live! Casino (MD)
1	2	2		Homer Lovers 40's (ON)			1	2	5		Ponce P. Rico/1st Cap. (NY)
2	1	3		S2S/.40 CAL (FL)			2	1	6		Y'All Next (MD)

Friday • February 8, 2019 • Auburndale Sports Complex • Auburndale

Field address ► 299 Florida Citrus Blvd. • Winter Haven, FL 33880

Time	#	Runs	Team Name	Field	#	Runs	Team Name
1:00 PM	2	20	Homer Lovers 40's (ON)	3	3	22	S2S/.40 CAL (FL)
1:00 PM	6	28	Y'All Next (MD)	4	4	24	Live! Casino (MD)
1:00 PM	5	19	Ponce P. Rico/1st Cap. (NY)	5	1	22	¥ Suncoast Adidas 40's (FL)
2:30 PM	3	21	¶ S2S/.40 CAL (FL)	3	6	15	Y'All Next (MD)
2:30 PM	4	17	Live! Casino (MD)	4	5	18	Ponce P. Rico/1st Cap. (NY)
2:30 PM	1	28	§ Suncoast Adidas 40's (FL)	5	2	36	Homer Lovers 40's (ON)

Saturday • February 9, 2019 • Auburndale Sports Complex • Auburndale

Time	#	Runs	Team Name	Field	#	Runs	Team Name
8:00 AM	2	22	¶ Homer Lovers 40's (ON)	4	4	25	Live! Casino (MD)
9:30 AM	5	21	Ponce P. Rico/1st Cap. (NY)	3	6	22	Y'All Next (MD)
9:30 AM	3	31	S2S/.40 CAL (FL)	4	1	33	§ Suncoast Adidas 40's (FL)

§ Team #1 GIVES 5-Run equalizer and is HOME vs. Teams #2-3 (Including bracket)

¶ Teams #2-3 GIVE 5-Run equalizer and are HOME vs. Teams #4-6

¥ Team #1 GIVES 7-Run equalizer and is HOME vs. Team #5

Seeding for 40-Platinum Double Elimination Bracket commencing Saturday afternoon - See Bracket for details

- Format:** Mixed 3-game Round Robin to seed 40-Masters Double Elimination Championship bracket
 Teams #1-3 play Double Elimination bracket for 40-Platinum Championship • INTERNAL SEEDING
NOTE Top finishing 40-Major AND Team #1 receive 1st place awards (trophy & rings)
 Teams #4-6 play Double Elimination bracket for 40-AAA Championship • INTERNAL SEEDING
 Home Runs - Home Run rule of LOWER rated team in game
 Major: Eight (8) per team per game, Outs AAA: Six (6) per team per game, Outs
NOTE SSUSA Official Rulebook §9.5 (Retrieving Home Run Balls) will be strictly enforced.
 Pitch Count - Batters start with "1-1" count (WITH Courtesy Foul) per SSUSA Rulebook §6.2 (2019 Rule)
 Run Rules - Five (5) runs per ½ inning at bat (except open inning)
 Time Limits - RR = 65 + open inn. • Bracket = 70 + open inn. • Championship game(s) = 7 innings full
 Tie Breakers - Head to head (in full RR only), least runs allowed, run differential, coin toss

Schedule Subject to Change at Discretion of Tournament and Field Directors



SSUSA's Original Tournament of Champions 2019

Polk County, Florida
February 8 - 10, 2019

Rev. 01/17/2019

Men's 40+ Masters Platinum Division • 3 Teams

Championship Bracket

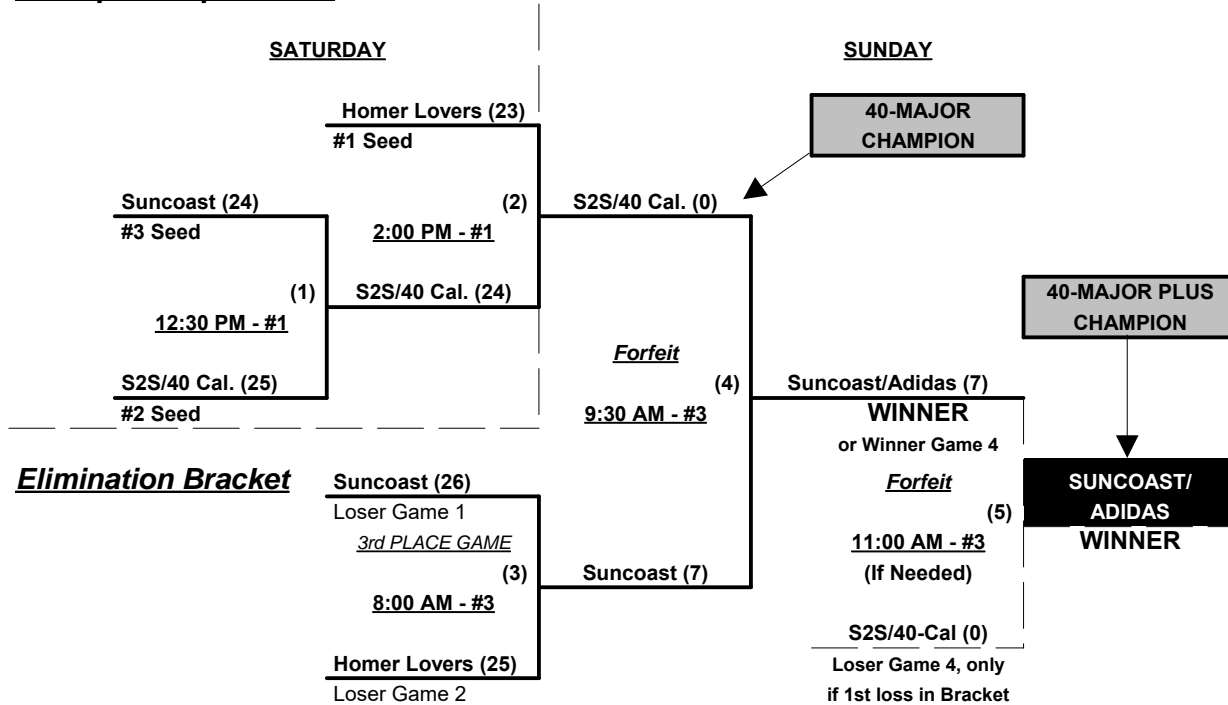

Men's 40+ Masters AAA Division • 3 Teams

Championship Bracket

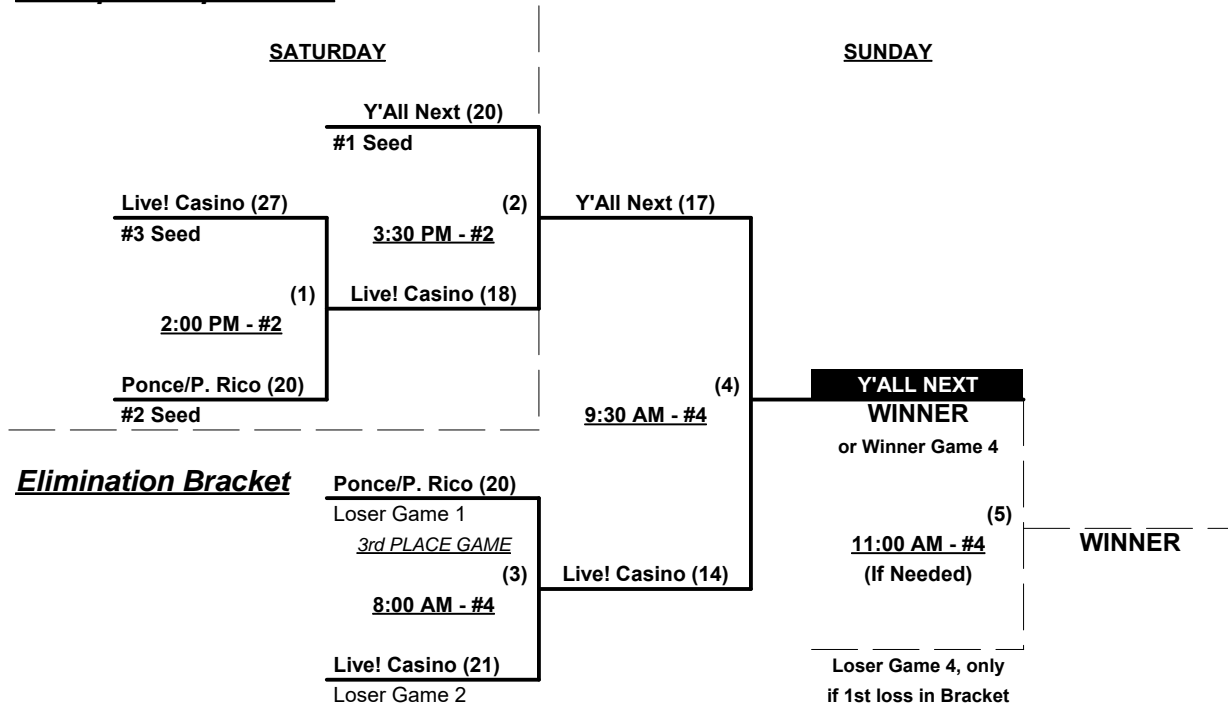



SSUSA's Original Tournament of Champions 2019

Polk County, Florida

February 8 - 10, 2019

Rev. 01/17/2019

Women's 40-Masters & 50+ Division • 7 Teams

Win	Loss		40/50-Major
0	3	1	Chill 40 Below (MD)
2	1	2	Kryptonite (FL)
2	1	3	Florida Girls 50

Win	Loss		40-Silver
3	0	4	CCS Fireballerz (CA)
2 (1)	1	5	Colorado Ohana
0	3	6	Fireballs (MA)
1	2	7	Dames Got Game (AZ)

Friday • February 8, 2019 • Walker Road Softball Complex • Lakeland

Field address ► 1285 Walker Road • Lakeland, FL 33810

Time	#	Runs	Team Name	Field	#	Runs	Team Name
9:00 AM	1	5	Chill 40 Below (MD)	1	2	23	Kryptonite (FL)
9:00 AM	6	14	¶ Fireballs (MA)	2	7	15	Dames Got Game (AZ)
9:00 AM	5	15	Colorado Ohana	3	4	16	CCS Fireballerz (CA)
10:30 AM	2	20	§ Kryptonite (FL)	1	6	13	Fireballs (MA)
10:30 AM	7	8	Dames Got Game (AZ)	2	5	17	¶ Colorado Ohana
10:30 AM	4	15	CCS Fireballerz (CA)	3	3	10	Florida Girls 50
12:00 PM	3	15	Florida Girls 50	3	1	11	§ Chill 40 Below (MD)

Saturday • February 9, 2019 • Walker Road Softball Complex • Lakeland

Time	#	Runs	Team Name	Field	#	Runs	Team Name
9:30 AM	2	16	§ Kryptonite (FL)	1	3	17	Florida Girls 50
9:30 AM	1	4	§ Chill 40 Below (MD)	2	5	8	Colorado Ohana
11:00 AM	7	12	Dames Got Game (AZ)	1	4	15	¶ CCS Fireballerz (CA)
11:00 AM	5	20	¥ Colorado Ohana	2	6	15	Fireballs (MA)

- § Teams #1-2 GIVE 5-Run equalizer and are HOME in games vs. Teams #3-6
- ¶ Team #4-6 GIVE 5-Run equalizer and are HOME in ALL games vs. Team #7
- ¥ Exhibition for Team #5 (ONLY) • Does NOT count in Round Robin standings

Seeding for Double Elimination Championship brackets commencing Saturday afternoon - See brackets

Format: Mixed three (3) game Round Robin to seed Double Elimination Championship brackets

Teams #1-3 play Double Elimination bracket for 40/50-Major Championship • INTERNAL SEEDING

NOTE Top finishing 40-Major AND Team #3 receive 1st place awards (trophy & rings)

Teams #4-7 play Double Elimination bracket for 40-Silver Championship

NOTE Top finishing 40-AAA AND Team #7 receive 1st place awards (trophy & rings)

Home Runs - Home Run rule of LOWER rated team in game Major = 6 per team per game, outs

AAA = 3 per team per game, outs AA = 1 per team per game, outs

NOTE SSUSA Official Rulebook §9.5 (Retrieving Home Run Balls) will be strictly enforced.

Pitch Count - Batters start with "1-1" count (WITH Courtesy Foul) per SSUSA Rulebook §6.2 (2019 Rule)

Run Rules - Five (5) runs per ½ inning at bat (except open inning)

Time Limits - RR = 65 + open inn. • Bracket = 70 + open inn. • Championship game(s) = 7 innings full

Tie Breakers - Head to head (in full RR only), least runs allowed, run differential, coin toss

Schedule Subject to Change at Discretion of Tournament and Field Directors



SSUSA's Original Tournament of Champions 2019
Polk County, Florida
February 8 - 10, 2019

Rev. 01/17/2019

Women's 40-Masters / 50+ Major Division • 3 Teams

Championship Bracket

SATURDAY

SUNDAY

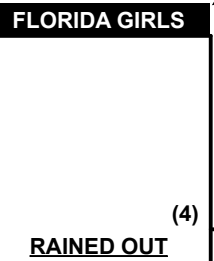
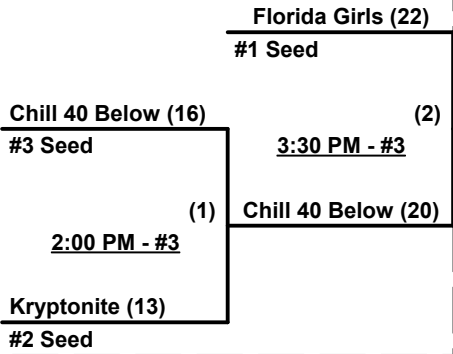

50-MAJOR CHAMPION

Elimination Bracket

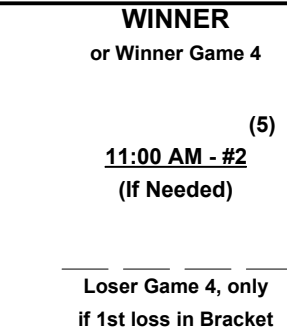
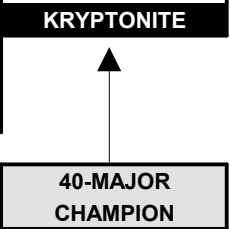

WINNER



SSUSA's Original Tournament of Champions 2019

Polk County, Florida
February 8 - 10, 2019

Rev. 01/17/2019

Women's 40+ Masters Silver Division • 4 Teams

Championship Bracket

SATURDAY

SUNDAY

CCS Fireballerz (25)

#1 Seed

(1) CCS Fireballerz (9)

2:00 PM - #4

Fireballs (13)

#4 Seed

**COLORADO
OHANA**

(3)

@ Loyce Harpe

Dames Game (14)

#3 Seed

(2) CO Ohana (11)

3:30 PM - #4

CO Ohana (23)

#2 Seed

(6)
RAINED OUT

WINNER

or Winner Game 6

Elimination Bracket

Loser Game 3

3rd PLACE GAME

(5)

Fireballs

Loser Game 1

RAINED OUT

(4)

RAINED OUT

Dames Got Game

Loser Game 2

(7)
2:00 PM - #1
(If Needed)

WINNER

Loser Game 6, only
if 1st loss in Bracket



SSUSA's Original Tournament of Champions 2019

Polk County, Florida

February 8 - 10, 2019

Rev. 01/17/2019

Men's 50/55+ Platinum Division • 7 Teams

<u>Win</u>	<u>Loss</u>		<u>50/55-Major+</u>	<u>Win</u>	<u>Loss</u>		<u>50-Major</u>
2	1	1	Suncoast Adidas 50's (FL)	1	1	3	CPD / Ancell 50's MN
0	3	2	RBC Wealth Mgmt. (FL)	1	1	4	Good Times/Clean Planet (F
				1	1	5	Homer Lovers 50's (ON)
				2	0	6	OG (CA)
				1	1	7	Stadium (CA)

Friday • February 8, 2019 • Auburndale Sports Complex • Auburndale

Field address ► 299 Florida Citrus Blvd. • Winter Haven, FL 33880

Time	#	Runs	Team Name	Field	#	Runs	Team Name
10:00 AM	1	27	§ Suncoast Adidas 50's (FL)	1	3	26	CPD / Ancell 50's MN
11:30 AM	6	18	OG (CA)	1	1	10	§ Suncoast Adidas 50's (FL)
11:30 AM	2	11	RBC Wealth Mgmt. (FL)	2	4	18	Good Times/Clean Planet (FL)
1:00 PM	3	25	CPD / Ancell 50's MN	1	7	22	Stadium (CA)
1:00 PM	4	20	Good Times/Clean Planet (FL)	2	6	25	OG (CA)
2:30 PM	7	19	Stadium (CA)	1	2	12	RBC Wealth Mgmt. (FL)
2:30 PM	1	25	§ Suncoast Adidas 50's (FL)	2	5	23	Homer Lovers 50's (ON)
4:00 PM	5	14	Homer Lovers 50's (ON)	1	2	13	RBC Wealth Mgmt. (FL)

Seeding for 50-Major Three-game-guarantee Bracket commencing Saturday morning - See Bracket for details

Saturday • February 9, 2019 • Auburndale Sports Complex • Auburndale

Time	#	Runs	Team Name	Field	#	Runs	Team Name
11:00 AM	2	38	RBC Wealth Mgmt. (FL)	5	1	35	§ Suncoast Adidas 50's (FL)
12:30 PM	2	18	RBC Wealth Mgmt. (FL)	5	1	22	§ Suncoast Adidas 50's (FL)
3:30 PM	2	NO	RBC Wealth Mgmt. (FL)	5	1	GAME	§ Suncoast Adidas 50's (FL)

§ Team #1 GIVES 5-Run OR 11-Defensive-player equalizer and is HOME in AL games

Format: Two (2) game Round Robin to seed 50-Major Three-game-guarantee bracket

Teams #1-2 play Best 2 of 3 Series for 50/55-Major+ Championship ON SATURDAY

NOTE BOTH teams receive 1st place awards (trophy & rings) in respective divisions

Teams #3-7 play Three-game-guarantee bracket for 50-Major Championship

Home Runs - Home Run rule of LOWER rated team in game

Major+ = 9 per team per game, Outs

Major = 6 per team per game, Outs

NOTE SSUSA Official Rulebook §9.5 (Retrieving Home Run Balls) will be strictly enforced.

Pitch Count - Batters start with "1-1" count (WITH Courtesy Foul) per SSUSA Rulebook §6.2 (2019 Rule)

Run Rules - SEEDING GAMES • Five (5) runs per ½ inning at bat (except open inning)

MAJOR+ BEST 2 OF 3 • Seven (7) runs per ½ inning at bat (except open inning)

Run Rules - Fifteen (15) runs after five (5) innings • MAJOR+ BEST 2 OF 3 ONLY

Time Limits - RR = 65 + open inn. • Bracket = 70 + open inn. • Championship game(s) = 7 innings full

Tie Breakers - Head to head (in full RR only), least runs allowed, run differential, coin toss

Schedule Subject to Change at Discretion of Tournament and Field Directors



SSUSA's Original Tournament of Champions 2019

Polk County, Florida February 8 - 10, 2019

Rev. 01/17/2019

Men's 50+ Major Division • 5 Teams

Championship Bracket

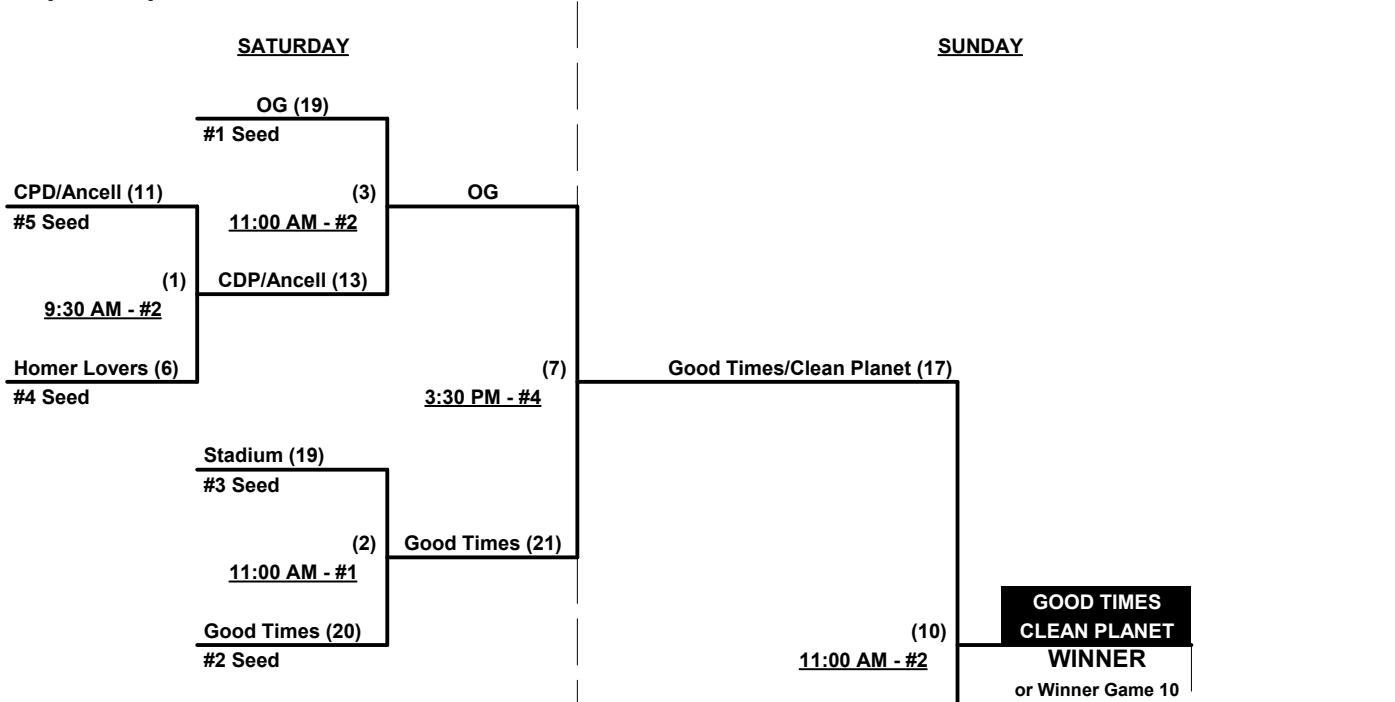

Elimination Bracket

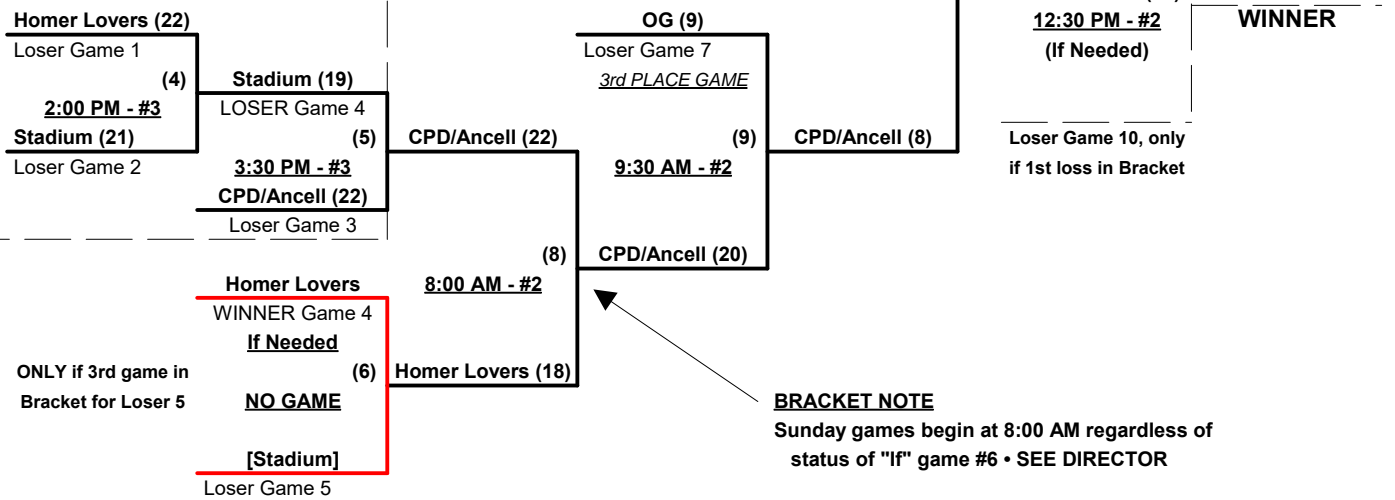



SSUSA's Original Tournament of Champions 2019

Polk County, Florida

February 8 - 10, 2019

Rev. 01/17/2019

Men's 50+ AAA Division • 8 Teams

Win	Loss		Team Name
0	2	1	Big Bottom Brewery (PA)
1	1	2	Finance of America (NJ)
1	1	3	Lansing Legends (MI)
1	1	4	ManCave/WorkSteps (TX)

Win	Loss		Team Name
2	0	5	No Shows (FL)
0	2	6	Sin City Warriors (NV)
1	1	7	Team 757 (VA)
2	0	8	Thunderstruck (AZ)

Friday • February 8, 2019 • Loyce Harpe Park Softball Complex • Lakeland

Field address ► 500 West Carter Rd. • Lakeland, FL 33815

Time	#	Runs	Team Name	Field	#	Runs	Team Name
9:00 AM	1	21	Big Bottom Brewery (PA)	1	4	22	ManCave/WorkSteps (TX)
9:00 AM	7	12	Team 757 (VA)	2	3	17	Lansing Legends (MI)
9:00 AM	8	15	Thunderstruck (AZ)	3	2	13	Finance of America (NJ)
9:00 AM	6	16	Sin City Warriors (NV)	4	5	20	No Shows (FL)
10:30 AM	4	13	ManCave/WorkSteps (TX)	1	7	16	Team 757 (VA)
10:30 AM	3	17	Lansing Legends (MI)	2	8	18	Thunderstruck (AZ)
10:30 AM	2	15	Finance of America (NJ)	3	6	11	Sin City Warriors (NV)
10:30 AM	5	22	No Shows (FL)	4	1	9	Big Bottom Brewery (PA)

Seeding for 50-AAA Three-game-guarantee bracket commencing Saturday morning - See Bracket for details

Format: Two (2) game Round Robin to seed 50-AAA Three-game-guarantee Bracket

Home Runs - AAA = 3 per team per game, Outs

NOTE SSUSA Official Rulebook §9.5 (Retrieving Home Run Balls) will be strictly enforced.

Pitch Count - Batters start with "1-1" count (WITH Courtesy Foul) per SSUSA Rulebook §6.2 (2019 Rule)

Time Limits - RR = 65 + open inn. • Bracket = 70 + open inn. • Championship game(s) = 7 innings full

Tie Breakers - Head to head (in full RR only), least runs allowed, run differential, coin toss

Schedule Subject to Change at Discretion of Tournament and Field Directors



SSUSA's Original Tournament of Champions 2019

Polk County, Florida

February 8 - 10, 2019

Rev. 01/17/2019

Men's 50+ AAA Division • 8 Teams

Championship Bracket

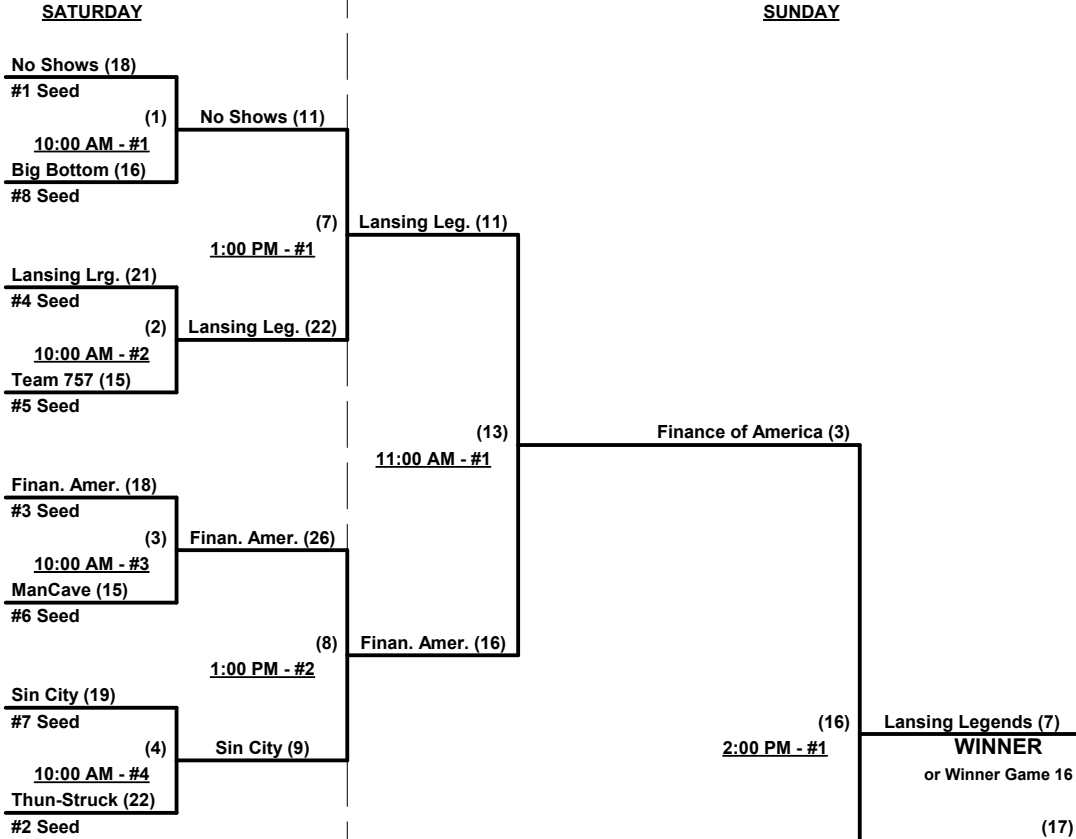

FINANCE OF AMERICA WINNER

Elimination Bracket



Finan. Amer. (14)
Loser Game 16, only if 1st loss in Bracket



SSUSA's Original Tournament of Champions 2019

Polk County, Florida

February 8 - 10, 2019

Rev. 01/17/2019

Men's 55+ Major Division • 4 Teams

Win	Loss		
0	3	1	Arizona Old School 55
2	1	2	Buell Fuel (NY)

Win	Loss		
1	2	3	Doug & Don's Auto (MI)
3	0	4	Florida Automated Shade

Friday • February 8, 2019 • Auburndale Sports Complex • Auburndale

Field address ► 299 Florida Citrus Blvd. • Winter Haven, FL 33880

Time	#	Runs	Team Name	Field	#	Runs	Team Name
8:30 AM	1	16	Arizona Old School 55	4	2	24	Buell Fuel (NY)
10:00 AM	4	23	Florida Automated Shade	4	3	19	Doug & Don's Auto (MI)
11:30 AM	2	7	Buell Fuel (NY)	3	4	28	Florida Automated Shade
11:30 AM	3	18	Doug & Don's Auto (MI)	4	1	17	Arizona Old School 55

Saturday • February 9, 2019 • Auburndale Sports Complex • Auburndale

Time	#	Runs	Team Name	Field	#	Runs	Team Name
9:30 AM	3	10	Doug & Don's Auto (MI)	1	2	18	Buell Fuel (NY)
9:30 AM	1	16	Arizona Old School 55	5	4	24	Florida Automated Shade

Seeding for 55-Major Double Elimination bracket commencing Saturday afternoon - See Bracket for details

Format: Full (3-game) Round Robin to seed 55-Major Double Elimination bracket

Home Runs - Major = 6 per team per game, Outs

NOTE SSUSA Official Rulebook §9.5 (Retrieving Home Run Balls) will be strictly enforced.

Pitch Count - Batters start with "1-1" count (WITH Courtesy Foul) per SSUSA Rulebook §6.2 (2019 Rule)

Run Rules - Five (5) runs per ½ inning at bat (except open inning)

Time Limits - RR = 65 + open inn. • Bracket = 70 + open inn. • Championship game(s) = 7 innings full

Tie Breakers - Head to head (in full RR only), least runs allowed, run differential, coin toss

Schedule Subject to Change at Discretion of Tournament and Field Directors



SSUSA's Original Tournament of Champions 2019

Polk County, Florida

February 8 - 10, 2019

Rev. 01/17/2019

Men's 55+ Major Division • 4 Teams

Championship Bracket

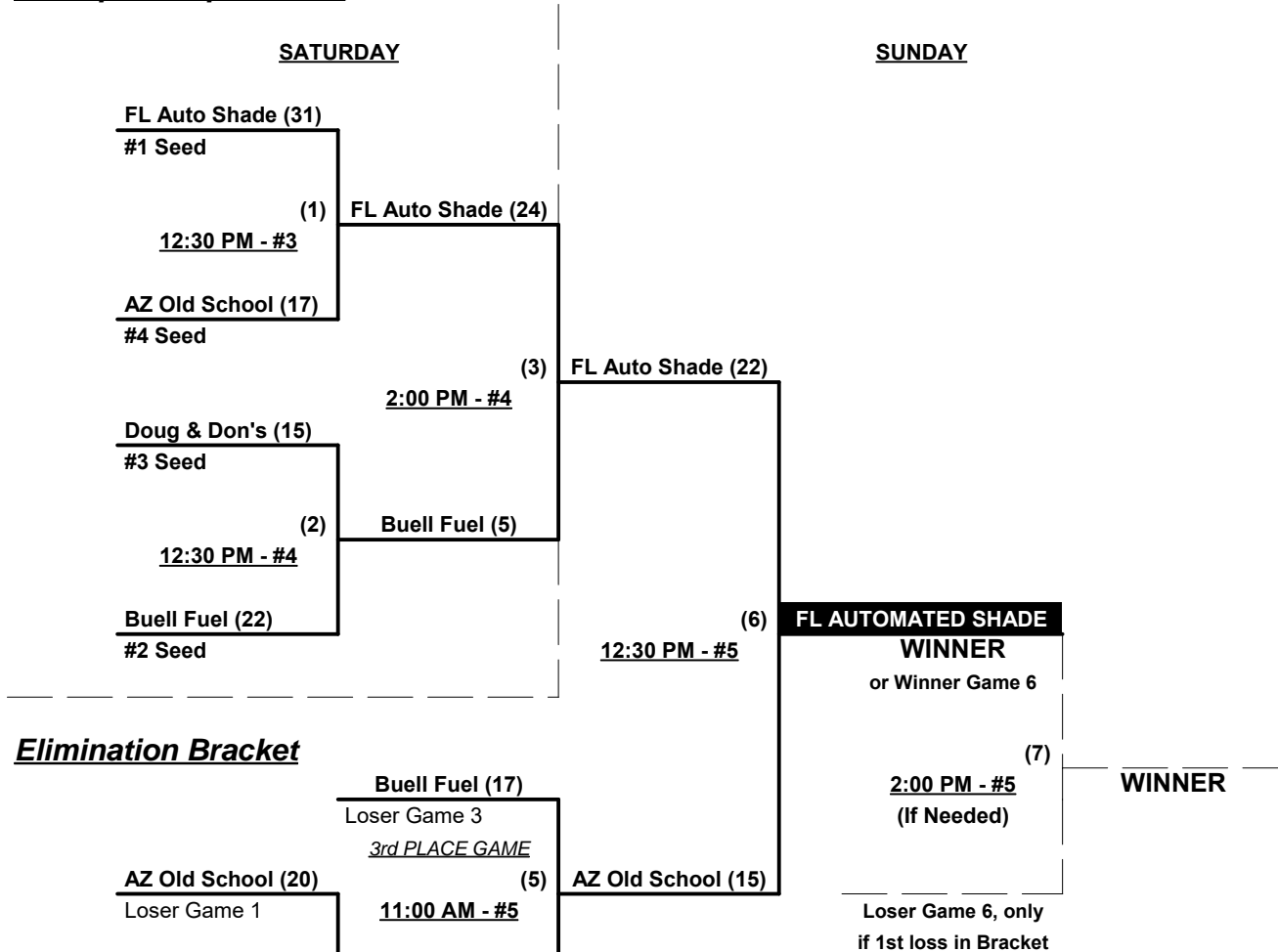

Elimination Bracket



SSUSA's Original Tournament of Champions 2019

Polk County, Florida

February 8 - 10, 2019

Rev. 01/17/2019

Men's 50/55+ Silver Division • 8 Teams

Win	Loss		Team Name
2	1	1	Ameriprise FL Legends 55's
2	1	2	Arizona Scorpions 55's
1	2	3	Bear's Ballers (MO)
3	0	4	GAP Sports 55 (FL)

Win	Loss		Team Name
2	1	5	Kamikaze (CA)
2	1	6	Los Vatos Viejos 55 (AZ)
0	3	7	Gray Ghost 50's (IL)
0	3	8	Longshoremen 55 (VA)

Friday • February 8, 2019 • Loyce Harpe Park Softball Complex • Lakeland

Field address ► 500 West Carter Rd. • Lakeland, FL 33815

Time	#	Runs	Team Name	Field	#	Runs	Team Name
12:00 PM	1	17	Ameriprise FL Legends 55's	1	6	8	Los Vatos Viejos 55 (AZ)
12:00 PM	7	19	Gray Ghost 50's (IL)	2	3	20	Bear's Ballers (MO)
12:00 PM	5	17	Kamikaze (CA)	3	4	24	GAP Sports 55 (FL)
12:00 PM	8	9	§ Longshoremen 55 (VA)	4	2	13	Arizona Scorpions 55's
1:30 PM	6	18	Los Vatos Viejos 55 (AZ)	1	7	7	Gray Ghost 50's (IL)
1:30 PM	3	8	Bear's Ballers (MO)	2	5	23	Kamikaze (CA)
1:30 PM	4	21	GAP Sports 55 (FL)	3	8	12	§ Longshoremen 55 (VA)
1:30 PM	2	15	Arizona Scorpions 55's	4	1	12	Ameriprise FL Legends 55's

Saturday • February 9, 2019 • Loyce Harpe Park Softball Complex • Lakeland

Time	#	Runs	Team Name	Field	#	Runs	Team Name
8:30 AM	8	10	§ Longshoremen 55 (VA)	1	5	17	Kamikaze (CA)
8:30 AM	1	19	Ameriprise FL Legends 55's	2	7	12	Gray Ghost 50's (IL)
8:30 AM	6	19	Los Vatos Viejos 55 (AZ)	3	3	15	Bear's Ballers (MO)
8:30 AM	2	15	Arizona Scorpions 55's	4	4	22	GAP Sports 55 (FL)

§ Team #8 RECEIVES 5-Run OR 11-Defensive-player equalizer and is VISITOR in ALL games

Seeding for 55-AAA Double Elimination bracket commencing Saturday morning - See Bracket for details

Format: Mixed (3-game) Round Robin to seed 55-AAA Double Elimination Championship bracket

Teams #1-6 play Double Elimination bracket for 55-AAA Championship

Teams #7-8 play Best 2 of 3 Series for 50/55-AA Championship

NOTE BOTH teams receive 1st place awards (trophy & rings) in respective divisions

Home Runs - Home Run rule of LOWER rated team in game

AAA = 3 per team per game, Outs AA = 1 per team per game, Outs

NOTE SSUSA Official Rulebook §9.5 (Retrieving Home Run Balls) will be strictly enforced.

Pitch Count - Batters start with "1-1" count (WITH Courtesy Foul) per SSUSA Rulebook §6.2 (2019 Rule)

Time Limits - RR = 65 + open inn. • Bracket = 70 + open inn. • Championship game(s) = 7 innings full

Tie Breakers - Head to head (in full RR only), least runs allowed, run differential, coin toss

Schedule Subject to Change at Discretion of Tournament and Field Directors



SSUSA's Original Tournament of Champions 2019

Polk County, Florida
February 8 - 10, 2019

Rev. 01/17/2019

Men's 55+ AAA Division • 6 Teams

Championship Bracket

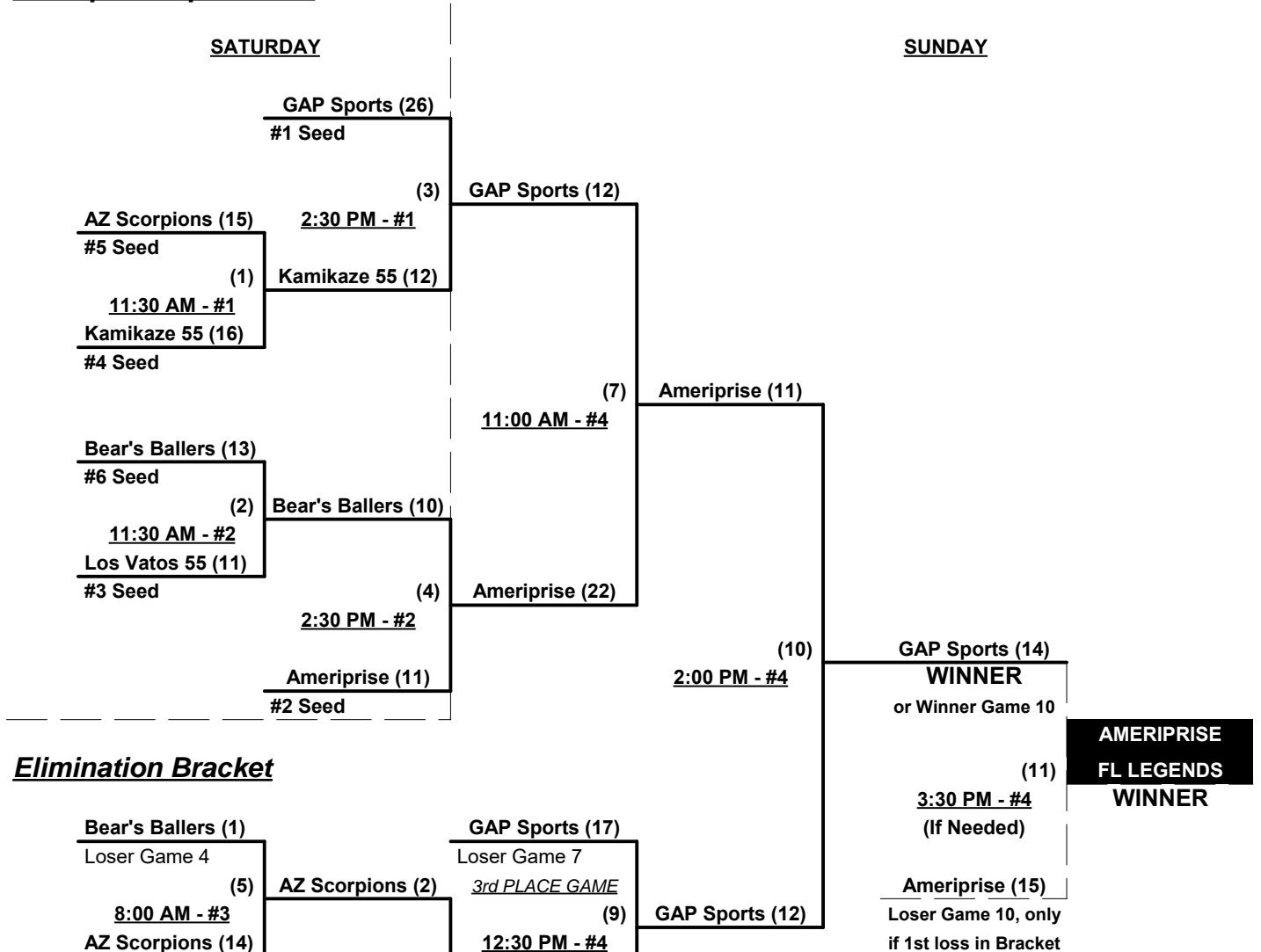

Elimination Bracket

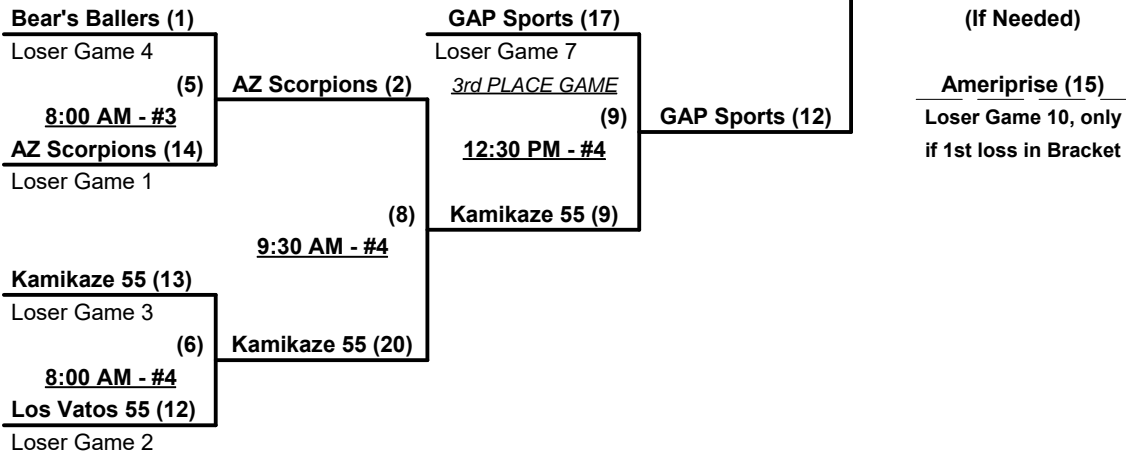



SSUSA's Original Tournament of Champions 2019
Polk County, Florida
February 8 - 10, 2019

Rev. 01/17/2019

Men's 50/55+ AA Division • 2 Teams

Championship Bracket

SATURDAY

Gray Ghost (23)

(1)

11:30 AM - #3

Longshoremen (22)

SUNDAY

GRAY GHOST

(2)

CANCELED

Longshoremen

Loser Game 1

WINNER

OR Winner Game 2

(3)

11:00 AM - #2

(If Needed)

WINNER

Loser Game 2, only
if 1st loss in Bracket

Elimination Game



SSUSA's Original Tournament of Champions 2019

Polk County, Florida

February 8 - 10, 2019

Rev. 01/30/2019

Men's 60/65+ Platinum Division • 8 Teams

Win	Loss
2	1
•	•
2	1
0	3
1	2

- 1 Florida Stingers
- 2 Hollis Appraisal 60 (FL) • OUT
- 3 Timberworks/Adidas 65 (CA)
- 4 AMR/Clean Planet (MI)
- 5 Cardot/Madalena (NY)

Win	Loss
1	2
3	0
0	3
3	0

- 6 Central Illinois Chiefs 60's
- 7 Levin/Ameriprise (FL)
- 8 Tasty Pizza (MN)
- 9 Windy City Softball (IL)

Friday • February 8, 2019 • Diamondplex Softball Complex • Winter Haven

Field address ► 999 Avenue H NE • Winter Haven, FL 33881

Time	#	Runs	Team Name	Field	#	Runs	Team Name
8:30 AM	4	7	AMR/Clean Planet (MI)	B	7	12	Levin/Ameriprise (FL)
8:30 AM	6	15	Central Illinois Chiefs 60's	C	1	22	§ Florida Stingers
8:30 AM	9	22	Windy City Softball (IL)	D	5	10	Cardot/Madalena (NY)
8:30 AM	8	14	Tasty Pizza (MN)	E	3	25	Timberworks/Adidas 65 (CA)
10:00 AM	7	21	Levin/Ameriprise (FL)	B	6	12	Central Illinois Chiefs 60's
10:00 AM	1	25	§ Florida Stingers	C	9	26	Windy City Softball (IL)
10:00 AM	5	30	Cardot/Madalena (NY)	D	8	25	Tasty Pizza (MN)
10:00 AM	3	19	Timberworks/Adidas 65 (CA)	E	4	9	AMR/Clean Planet (MI)

Saturday • February 9, 2019 • Diamondplex Softball Complex • Winter Haven

Time	#	Runs	Team Name	Field	#	Runs	Team Name
8:00 AM	1	21	§ Florida Stingers	B	5	10	Cardot/Madalena (NY)
8:00 AM	7	17	Levin/Ameriprise (FL)	C	3	16	Timberworks/Adidas 65 (CA)
8:00 AM	8	15	Tasty Pizza (MN)	D	6	22	Central Illinois Chiefs 60's
8:00 AM	4	19	AMR/Clean Planet (MI)	E	9	20	Windy City Softball (IL)

§ Team #1 GIVES 5-Run OR 11-Defensive-player equalizer and is HOME in ALL games

Seeding for 60-Major Double Elimination bracket commencing Saturday afternoon - See bracket for details

Format: Mixed (3-game) Round Robin to seed 60-Major Double Elimination championship bracket

Teams #1 and 3 play Best 2 of 3 Series for 60/65-Major+ championship ON SATURDAY

NOTE BOTH teams receive 1st place awards (trophy & rings) in respective divisions

Teams #4-9 play Double Elimination bracket for 60-Major championship

Home Runs - Major = 6 per team per game, Outs Major+ Best 2 of 3 = 9 per team per game, Outs

NOTE SSUSA Official Rulebook §9.5 (Retrieving Home Run Balls) will be strictly enforced.

Run Rules - Five (5) runs per ½ inning at bat (except open inning) • Seven runs in Major+ Best 2 of 3

Pitch Count - Batters start with "1-1" count (WITH Courtesy Foul) per SSUSA Rulebook §6.2 (2019 Rule)

NOTE If Timberworks/Adidas in game • Starting pitch count is "0-0" for both teams

Mercy Rule - Fifteen (15) runs after five (5) innings • Major+ Best 2 of 3 Series ONLY

Time Limits - RR = 65 + open inn. • Bracket = 70 + open inn. • Championship game(s) = 7 innings full

Tie Breakers - Head to head (in full RR only), least runs allowed, run differential, coin toss

Schedule Subject to Change at Discretion of Tournament and Field Directors



SSUSA's Original Tournament of Champions 2019
Polk County, Florida
February 8 - 9, 2019

Rev. 02/01/2019

Men's 60/65+ Major+ Division • 2 Teams

Championship Bracket

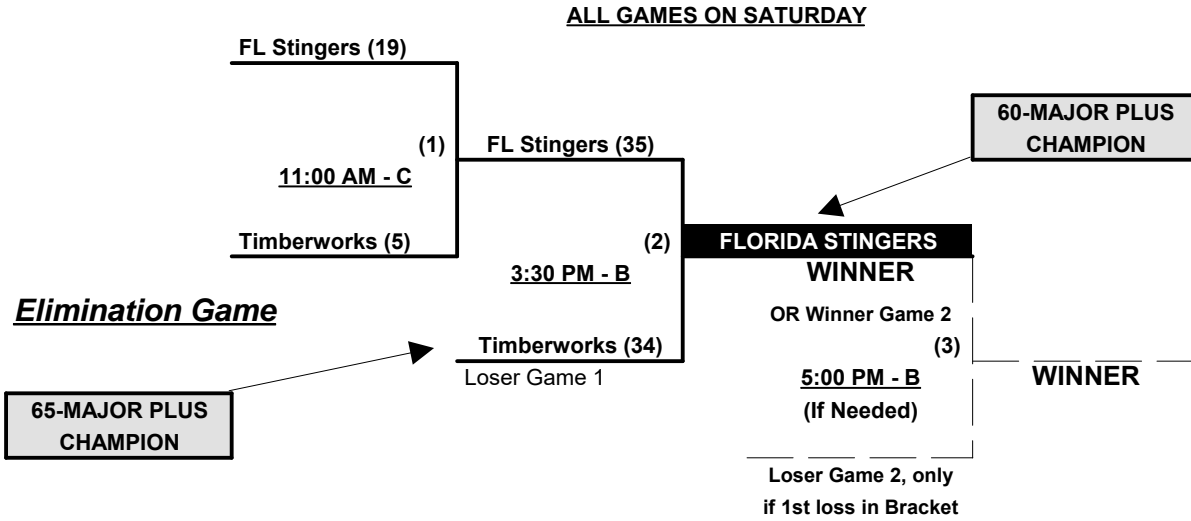



SSUSA's Original Tournament of Champions 2019

Polk County, Florida
February 8 - 10, 2019

Rev. 01/30/2019

Men's 60+ Major Division • 6 Teams

Championship Bracket

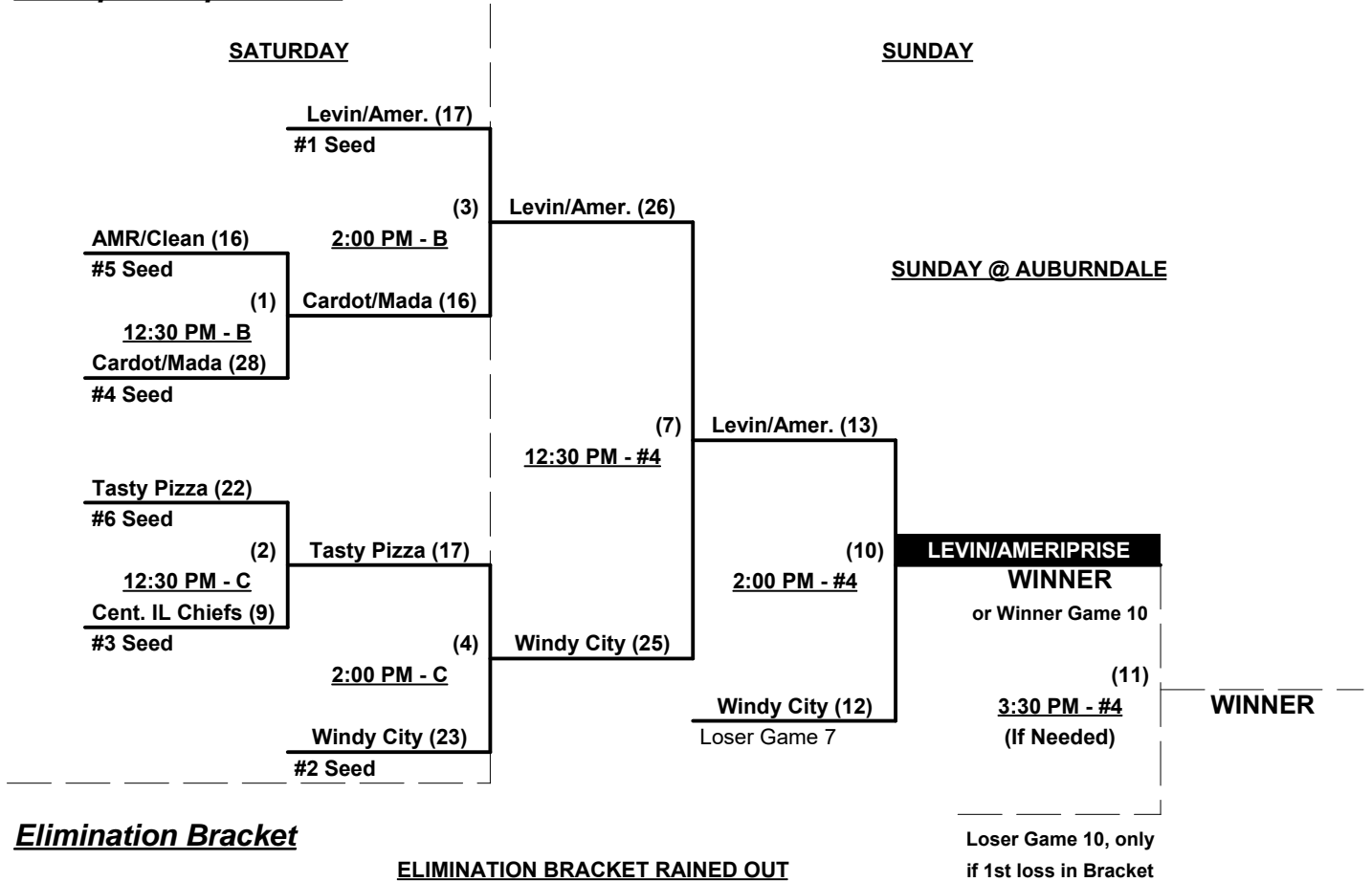

Elimination Bracket

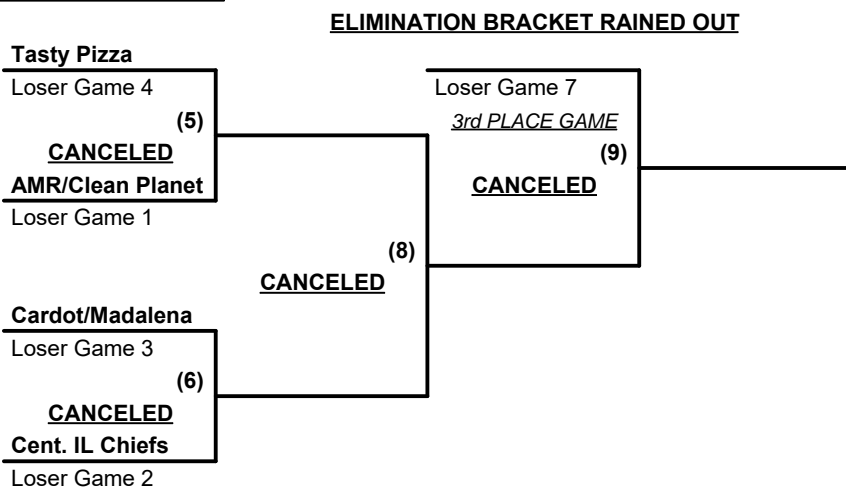



SSUSA's Original Tournament of Champions 2019

Polk County, Florida

February 8 - 10, 2019

Rev. 01/18/2019

Men's 60+ AAA Division • 8 Teams

Win	Loss		
2	0	1	Baker Boyz (CA)
1	1	2	Chicago Panthers (IL)
0	2	3	Collision Clinic (NF)
0	2	4	El Paso Old School 60 (TX)

Win	Loss		
2	0	5	NW Softball/Underdogs (WA)
1	1	6	Playmakers (WI)
1	1	7	RedHawk Nation (FL)
1	1	8	Silver Stars (CA)

Friday • February 8, 2019 • Auburndale Sports Complex • Auburndale

Field address ► 299 Florida Citrus Blvd. • Winter Haven, FL 33880

Time	#	Runs	Team Name	Field	#	Runs	Team Name
8:30 AM	1	18	Baker Boyz (CA)	1	2	14	Chicago Panthers (IL)
8:30 AM	7	20	RedHawk Nation (FL)	2	8	18	Silver Stars (CA)
8:30 AM	5	21	NW Softball/Underdogs (WA)	3	3	3	Collision Clinic (NF)
8:30 AM	6	15	Playmakers (WI)	5	4	4	El Paso Old School 60 (TX)
10:00 AM	8	22	Silver Stars (CA)	2	6	21	Playmakers (WI)
10:00 AM	3	10	Collision Clinic (NF)	3	1	21	Baker Boyz (CA)
10:00 AM	4	8	El Paso Old School 60 (TX)	5	5	18	NW Softball/Underdogs (WA)
11:30 AM	2	10	Chicago Panthers (IL)	5	7	9	RedHawk Nation (FL)

Seeding for 60-AAA Three-game-guarantee bracket commencing Saturday morning - See Bracket for details

Format: Two (2) game Round Robin to seed 60-AAA Three-game-guarantee Bracket

Home Runs - AAA = 3 per team per game, Outs

NOTE SSUSA Official Rulebook §9.5 (Retrieving Home Run Balls) will be strictly enforced.

Pitch Count - Batters start with "1-1" count (WITH Courtesy Foul) per SSUSA Rulebook §6.2 (2019 Rule)

Time Limits - RR = 65 + open inn. • Bracket = 70 + open inn. • Championship game(s) = 7 innings full

Tie Breakers - Head to head (in full RR only), least runs allowed, run differential, coin toss

Schedule Subject to Change at Discretion of Tournament and Field Directors



SSUSA's Original Tournament of Champions 2019
Polk County, Florida
February 8 - 10, 2019

Rev. 01/18/2019

Men's 60+ AAA Division • 8 Teams

Championship Bracket

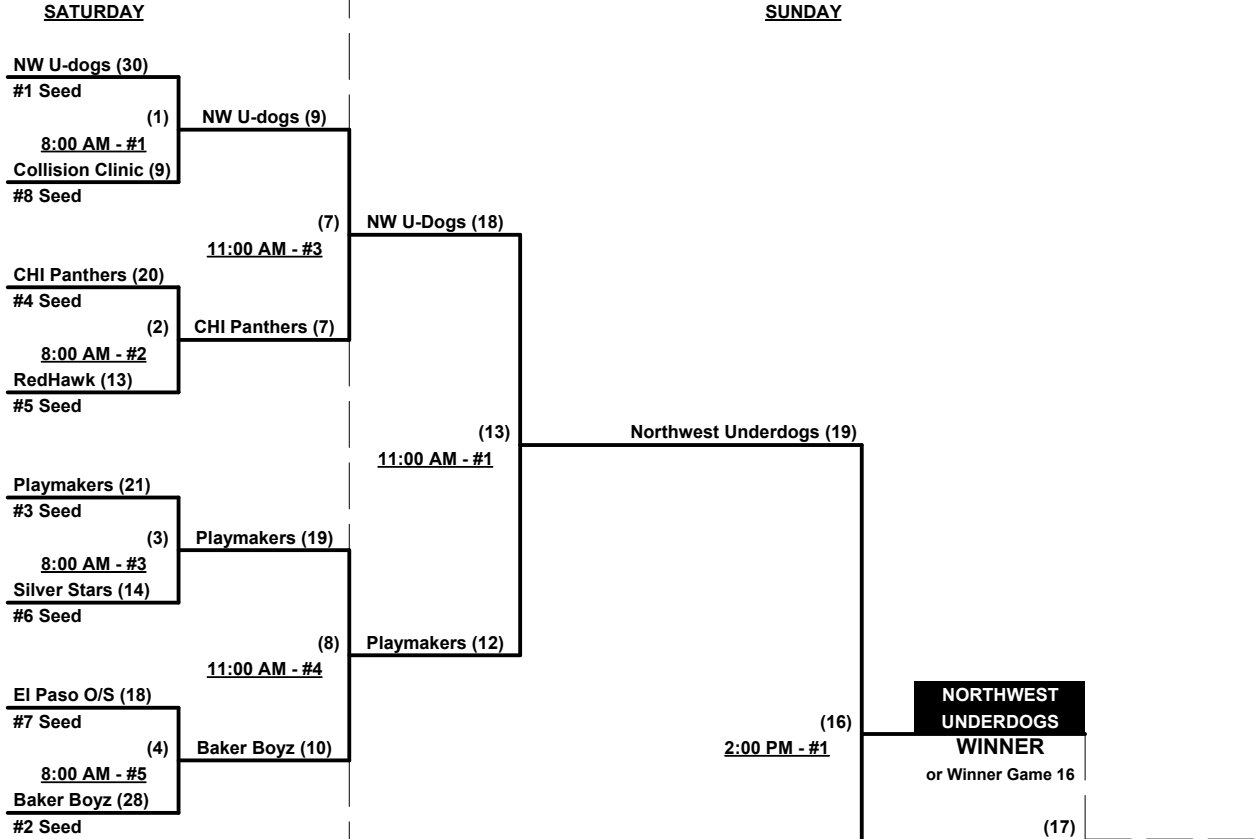

Elimination Bracket

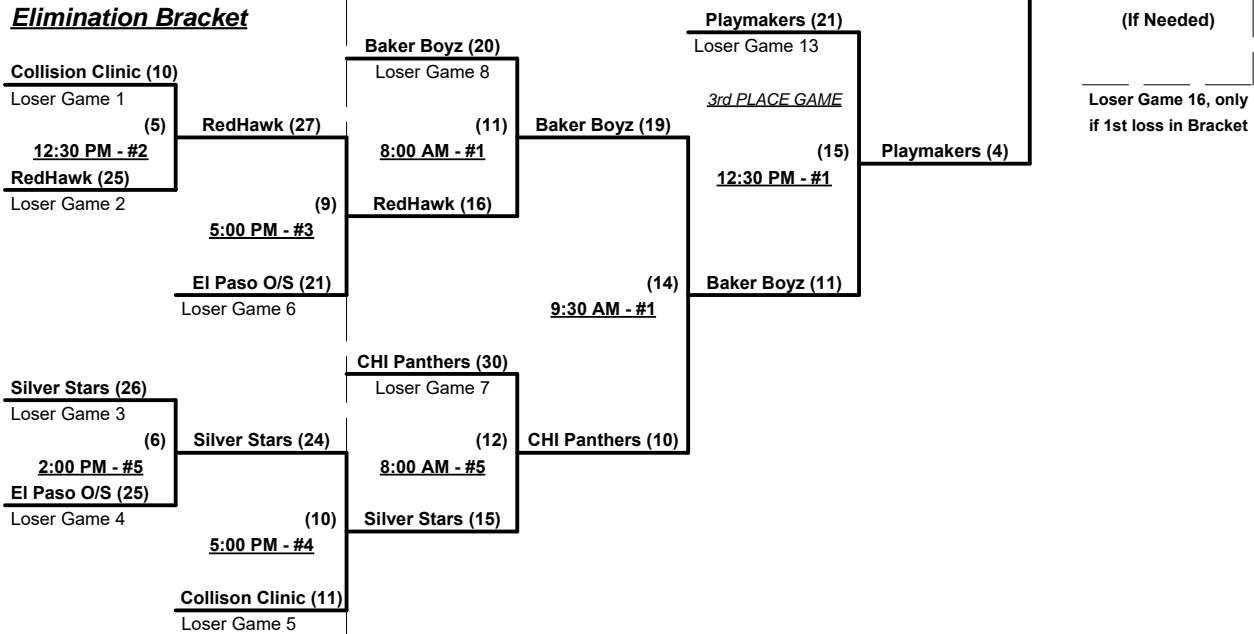



SSUSA's Original Tournament of Champions 2019

Polk County, Florida

February 8 - 10, 2019

Rev. 01/30/2019

Men's 60+ AA Division • 8 Teams

Win	Loss		Team Name
1	1	1	Austin Wizards (TX)
0	2	2	Family (NV)
1	1	3	Just One More/Mc-C-V (OH)
0	2	4	Los Vatos Viejos 60 (AZ)

Win	Loss		Team Name
2	0	5	Syracuse Cyclones 60 (NY)
1	1	6	Team Texas San Antonio
2	0	7	Ted Todd Insurance 60 (FL)
1	1	8	Texas Legends 60's

Friday • February 8, 2019 • Diamondplex Softball Complex • Winter Haven

Field address ► 999 Avenue H NE • Winter Haven, FL 33881

Time	#	Runs	Team Name	Field	#	Runs	Team Name
11:30 AM	1	19	Austin Wizards (TX)	D	4	17	Los Vatos Viejos 60 (AZ)
11:30 AM	7	25	Ted Todd Insurance 60 (FL)	D	3	9	Just One More/Mc-C-V (OH)
1:00 PM	8	15	Texas Legends 60's	E	2	7	Family (NV)
1:00 PM	6	10	Team Texas San Antonio	B	5	12	Syracuse Cyclones 60 (NY)
2:30 PM	5	19	Syracuse Cyclones 60 (NY)	C	1	16	Austin Wizards (TX)
2:30 PM	4	12	Los Vatos Viejos 60 (AZ)	D	7	17	Ted Todd Insurance 60 (FL)
2:30 PM	3	21	Just One More/Mc-C-V (OH)	E	8	11	Texas Legends 60's
2:30 PM	2	17	Family (NV)	C	6	18	Team Texas San Antonio

Seeding for 60-AA Three-game-guarantee bracket commencing Saturday morning - See Bracket for details

Format: Two (2) game Round Robin to seed 60-AA Three-game-guarantee Bracket

Home Runs - AA = 1 per team per game, Outs

NOTE SSUSA Official Rulebook §9.5 (Retrieving Home Run Balls) will be strictly enforced.

Pitch Count - Batters start with "1-1" count (WITH Courtesy Foul) per SSUSA Rulebook §6.2 (2019 Rule)

Time Limits - RR = 65 + open inn. • Bracket = 70 + open inn. • Championship game(s) = 7 innings full

Tie Breakers - Head to head (in full RR only), least runs allowed, run differential, coin toss

Schedule Subject to Change at Discretion of Tournament and Field Directors



SSUSA's Original Tournament of Champions 2019

Polk County, Florida
February 8 - 10, 2019

Rev. 01/30/2019

Men's 60+ AA Division • 8 Teams

Championship Bracket

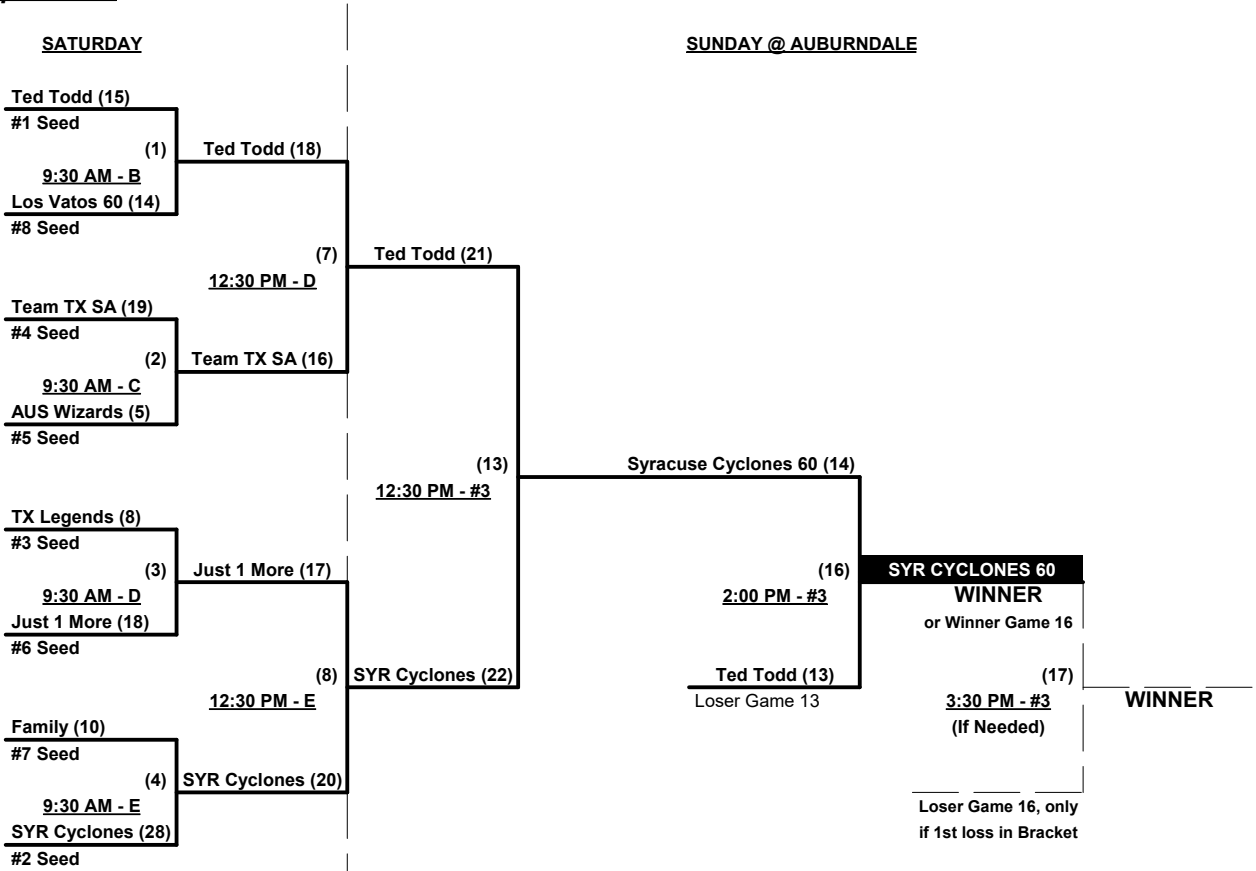

ELIMINATION BRACKET RAINED OUT

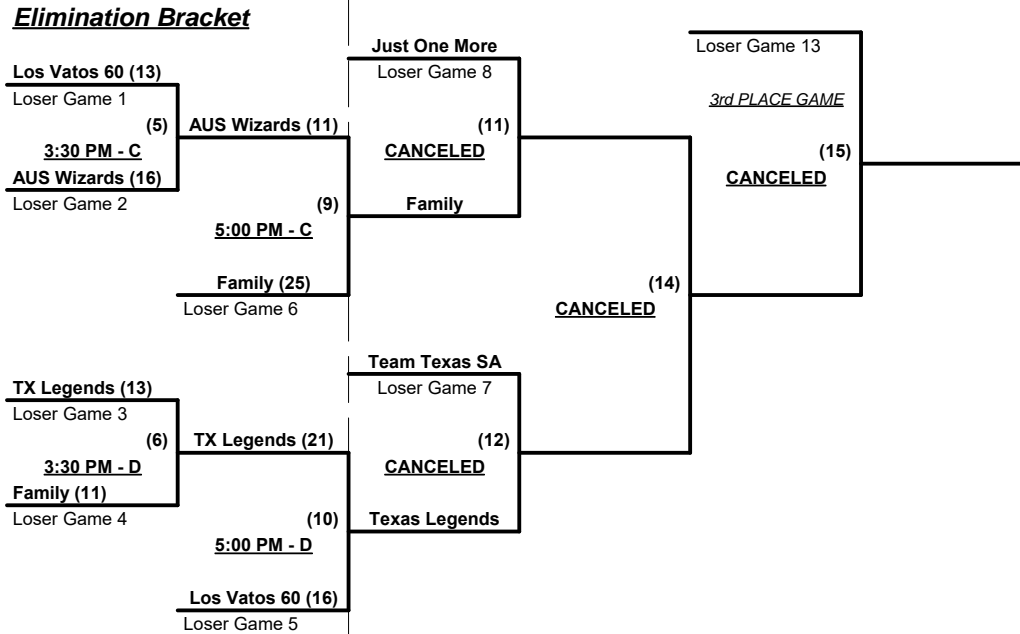



SSUSA's Original Tournament of Champions 2019

Polk County, Florida

February 8 - 10, 2019

Rev. 02/01/2019

Men's 65/70+ Platinum Division • 4 Teams

	<u>Win</u>	<u>Loss</u>			<u>Win</u>	<u>Loss</u>		
	1	2	1	Carolina Cobras (NC)	0	3	3	R&R 65's (CA)
	2	1	2	Handeland Flooring (WI)	3	0	4	Venom 70 (FL)

Friday • February 8, 2019 • Diamondplex Softball Complex • Winter Haven

Field address ► 999 Avenue H NE • Winter Haven, FL 33881

Time	#	Runs	Team Name	Field	#	Runs	Team Name
11:30 AM	1	14	Carolina Cobras (NC)	B	2	16	Handeland Flooring (WI)
11:30 AM	4	18	Venom 70 (FL)	C	3	1	R&R 65's (CA)
1:00 PM	2	9	Handeland Flooring (WI)	B	4	21	Venom 70 (FL)
1:00 PM	3	11	R&R 65's (CA)	C	1	21	Carolina Cobras (NC)

Saturday • February 9, 2019 • Diamondplex Softball Complex • Winter Haven

Time	#	Runs	Team Name	Field	#	Runs	Team Name
11:00 AM	1	11	Carolina Cobras (NC)	B	4	31	Venom 70 (FL)
11:00 AM	3	12	R&R 65's (CA)	C	2	21	Handeland Flooring (WI)

Seeding for 65/70-Platinum Double Elimination bracket commencing Saturday afternoon - See Bracket

Format: Full (3-game) Round Robin to seed 65/70-Platinum Double Elimination bracket

NOTE Top finishing 65-Major AND Team #4 receive 1st place awards (trophy & rings)

Home Runs - Major = 6 per team per game, Outs

NOTE SSUSA Official Rulebook §9.5 (Retrieving Home Run Balls) will be strictly enforced.

Pitch Count - Batters start with "0-0" count per SSUSA Rulebook §6.2 (Pitch Count)

Run Rules - Five (5) runs per ½ inning at bat (except open inning)

Time Limits - RR = 65 + open inn. • Bracket = 70 + open inn. • Championship game(s) = 7 innings full

Tie Breakers - Head to head (in full RR only), least runs allowed, run differential, coin toss

Schedule Subject to Change at Discretion of Tournament and Field Directors



SSUSA's Original Tournament of Champions 2019

Polk County, Florida
February 8 - 10, 2019

Rev. 01/17/2019

Men's 65/70+ Platinum Division • 4 Teams

Championship Bracket

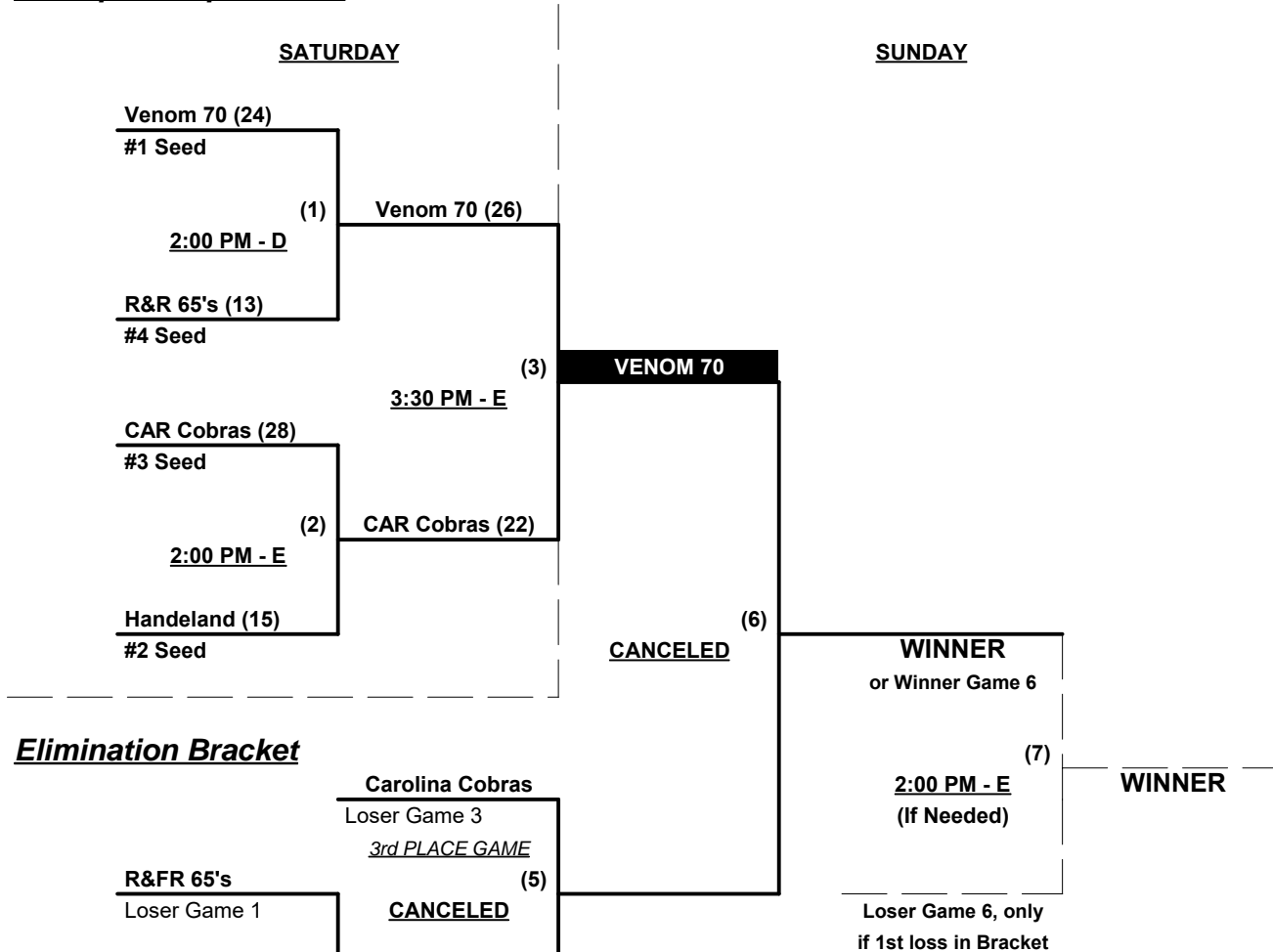



SSUSA's Original Tournament of Champions 2019

Polk County, Florida

February 8 - 10, 2019

Rev. 01/19/2019

Men's 65+ Silver Division • 12 Teams

Win	Loss		Win	Loss	
3	0	1 Acousti (FL)	0	3	7 L. Island Jags 65 Red (NY)
3	0	2 Aro Glass Clubbers (WA)	2	1	8 MP Comp./Bomb Squad (MI)
1	2	3 Bradford White (PA)	2	1	9 Pill & Pill 65 (WV)
2	1	4 Brantford Nissan Seniors (ON)	2	1	10 Sidewinders Desert 65 (AZ)
2	1	5 Dallas Spurs 65 (TX)	1	2	11 Grey Sox 65 (WA)
0	3	6 Jersey Masters Red (NJ)	0	3	12 Robinson's Furn./OTS (DE)

Friday • February 8, 2019 • Walker Road Softball Complex • Lakeland

Field address ► 1285 Walker Road • Lakeland, FL 33810

Time	#	Runs	Team Name	Field	#	Runs	Team Name
9:00 AM	1	14	Acousti (FL)	4	4	13	Brantford Nissan Seniors (ON)
10:30 AM	4	19	Brantford Nissan Seniors (ON)	4	10	18	Sidewinders Desert 65 (AZ)
12:00 PM	5	11	Dallas Spurs 65 (TX)	1	1	18	Acousti (FL)
12:00 PM	9	20	Pill & Pill 65 (WV)	2	6	16	Jersey Masters Red (NJ)
12:00 PM	10	10	Sidewinders Desert 65 (AZ)	4	3	7	Bradford White (PA)
1:30 PM	7	17	L. Island Jags 65 Red (NY)	1	5	22	Dallas Spurs 65 (TX)
1:30 PM	6	11	Jersey Masters Red (NJ)	2	2	14	Aro Glass Clubbers (WA)
1:30 PM	11	13	Grey Sox 65 (WA)	3	9	14	§ Pill & Pill 65 (WV)
1:30 PM	12	14	Robinson's Furn./OTS (DE)	4	8	22	§ MP Comp./Bomb Squad (MI)
3:00 PM	8	14	MP Comp./Bomb Squad (MI)	1	7	7	L. Island Jags 65 Red (NY)
3:00 PM	2	16	§ Aro Glass Clubbers (WA)	2	12	12	Robinson's Furn./OTS (DE)
3:00 PM	3	19	§ Bradford White (PA)	3	11	12	Grey Sox 65 (WA)

Saturday • February 9, 2019 • Walker Road Softball Complex • Lakeland

Time	#	Runs	Team Name	Field	#	Runs	Team Name
8:00 AM	11	29	Grey Sox 65 (WA)	1	6	25	§ Jersey Masters Red (NJ)
8:00 AM	10	20	§ Sidewinders Desert 65 (AZ)	2	12	8	Robinson's Furn./OTS (DE)
8:00 AM	2	13	Aro Glass Clubbers (WA)	3	7	10	L. Island Jags 65 Red (NY)
8:00 AM	5	18	Dallas Spurs 65 (TX)	4	3	6	Bradford White (PA)
9:30 AM	1	19	Acousti (FL)	3	8	18	MP Comp./Bomb Squad (MI)
9:30 AM	9	14	Pill & Pill 65 (WV)	4	4	21	Brantford Nissan Seniors (ON)

§ Teams #1-10 GIVE 5-Run OR 11-Defensive-player equalizer and are HOME vs. Teams #11-12

Format: Three (3) game Round Robin to seed 65-AAA Double Elimination bracket for Teams #1-10

Teams #11-12 play Best 2 of 3 Series for 65-AA Championship

Home Runs - Home Run rule of LOWER rated team in game

AAA = 3 per team per game, Outs AA = 1 per team per game, Outs

NOTE SSUSA Official Rulebook §9.5 (Retrieving Home Run Balls) will be strictly enforced.

Pitch Count - Batters start with "0-0" count per SSUSA Rulebook §6.2 (Pitch Count)

Time Limits - RR = 65 + open inn. • Bracket = 70 + open inn. • Championship game(s) = 7 innings full

Tie Breakers - Head to head (in full RR only), least runs allowed, run differential, coin toss

Schedule Subject to Change at Discretion of Tournament and Field Directors



SSUSA's Original Tournament of Champions 2019

Polk County, Florida
February 8 - 10, 2019

Rev. 01/17/2019

Men's 65+ AAA Division • 10 Teams

Championship Bracket

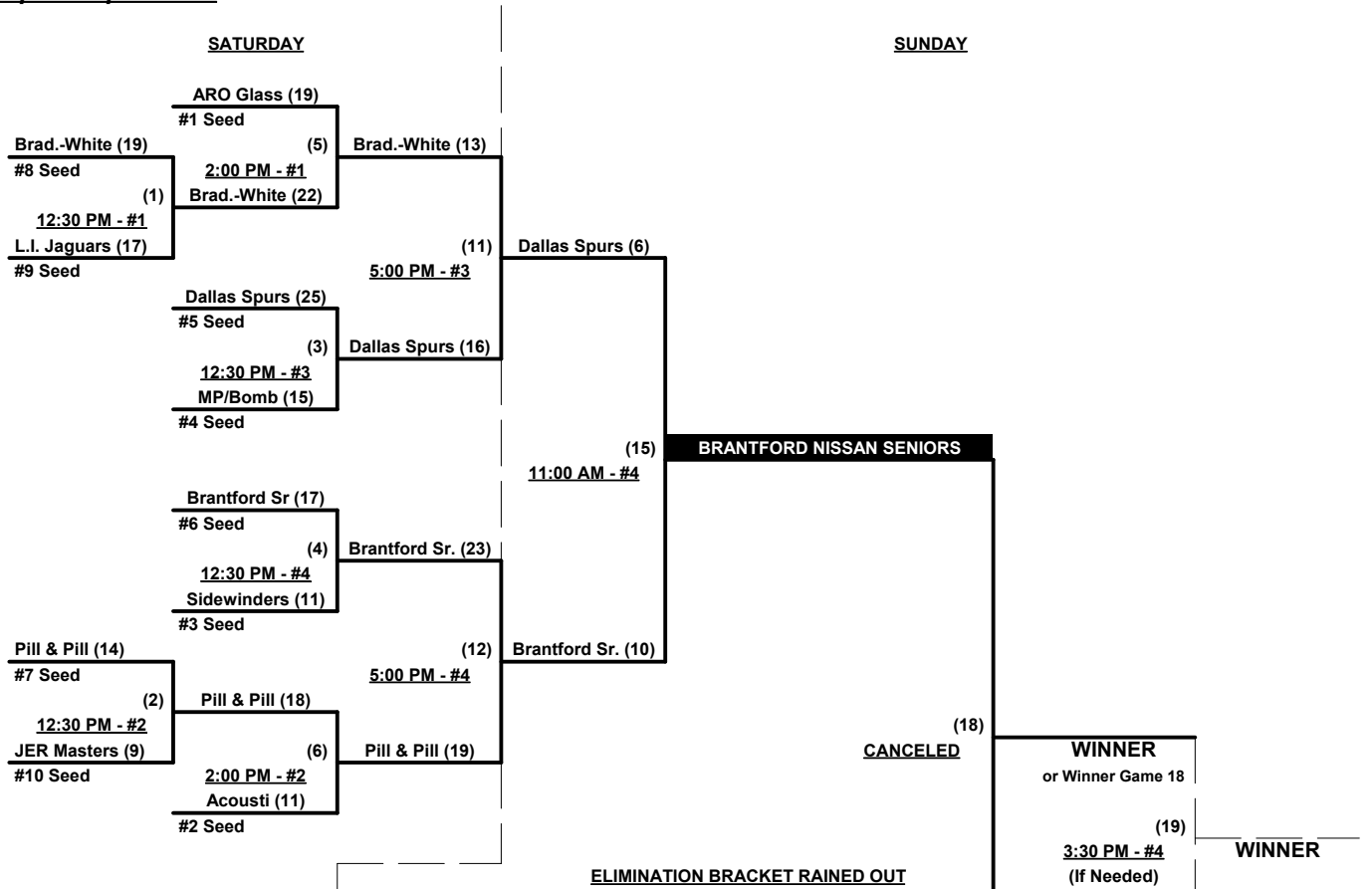

Elimination Bracket

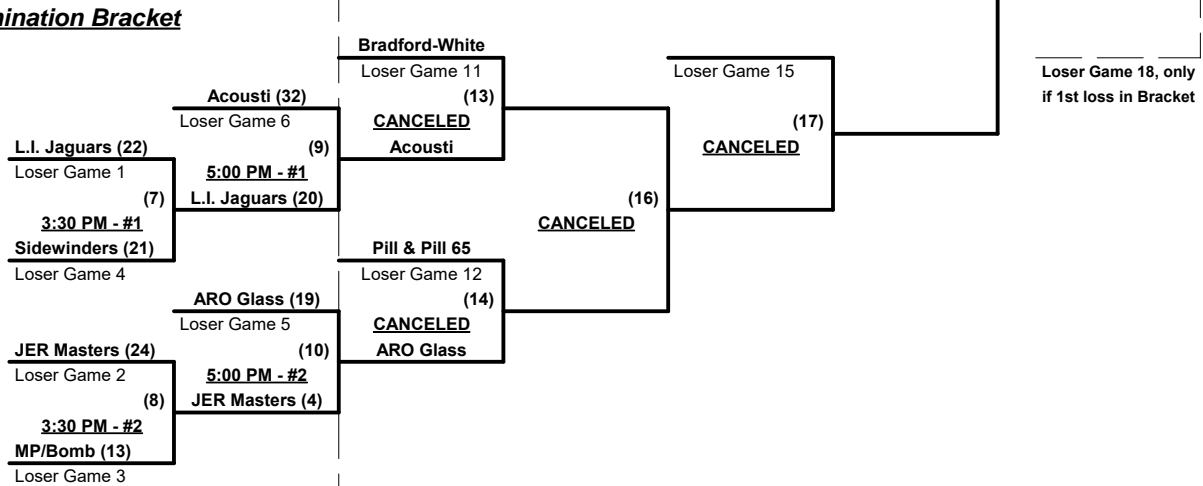

ELIMINATION BRACKET RAINED OUT



SSUSA's Original Tournament of Champions 2019
Polk County, Florida
February 8 - 10, 2019

Rev. 01/17/2019

Men's 65+ AA Division • 2 Teams

Championship Bracket

SATURDAY

GREY SOX (12)

(1)

11:00 AM - #4

ROBINSON'S (22)

SUNDAY

ROBINSON'S

(2)

CANCELED

GREY SOX

Loser Game 1

WINNER

OR Winner Game 2

(3)

11:00 AM - #3

(If Needed)

Loser Game 2, only
if 1st loss in Bracket

WINNER

Elimination Game



SSUSA's Original Tournament of Champions 2019

Polk County, Florida

February 8 - 10, 2019

Rev. 01/29/2019

Men's 70/75/80+ Gold Division • 10 Teams

Win	Loss		Win	Loss	
2	2	1 All-American (MN)	2	2	6 Windsor Chiefs (ON)
1	3	2 Florida Legends 75	3	3	7 Chicago Hitmen 70's (IL)
5	1	3 Lane Construction (FL)	1	3	8 Chadwell Supply (FL)
5	1	4 Midwest Express 70's (IA)	2	2	9 Monkey Joe's Big Nut (NJ)
0	6	5 Sacto. Islanders 70 (CA)	3	1	10 Florida Invest. Properties

Friday • February 8, 2019 • Southwest Softball Complex • Lakeland

Field address ► 1444 West Highlands Street • Lakeland, FL 33815

Time	#	Runs	Team Name	Field	#	Runs	Team Name
9:00 AM	10	28	Florida Invest. Properties	1	1	12	All-American (MN)
9:00 AM	5	16	¥ Sacto. Islanders 70 (CA)	2	9	20	Monkey Joe's Big Nut (NJ)
9:00 AM	3	14	¥ Lane Construction (FL)	3	7	12	Chicago Hitmen 70's (IL)
9:00 AM	2	18	§ Florida Legends 75	4	6	23	Windsor Chiefs (ON)
10:30 AM	9	13	Monkey Joe's Big Nut (NJ)	2	3	24	¥ Lane Construction (FL)
10:30 AM	7	24	Chicago Hitmen 70's (IL)	3	2	25	¶ Florida Legends 75
10:30 AM	6	15	¥ Windsor Chiefs (ON)	4	8	14	Chadwell Supply (FL)
12:00 PM	1	15	§ All-American (MN)	3	5	12	Sacto. Islanders 70 (CA)
12:00 PM	4	7	¥ Midwest Express 70's (IA)	4	10	8	Florida Invest. Properties
1:30 PM	8	17	Chadwell Supply (FL)	4	4	18	¥ Midwest Express 70's (IA)

Saturday • February 9, 2019 • Southwest Softball Complex • Lakeland

Time	#	Runs	Team Name	Field	#	Runs	Team Name
9:00 AM	8	20	Chadwell Supply (FL)	1	1	21	¶ All-American (MN)
9:00 AM	4	22	Midwest Express 70's (IA)	4	2	12	§ Florida Legends 75
10:30 AM	1	17	§ All-American (MN)	1	3	29	Lane Construction (FL)
10:30 AM	2	10	¶ Florida Legends 75	4	9	20	Monkey Joe's Big Nut (NJ)
12:00 PM	3	24	Lane Construction (FL)	1	6	11	Windsor Chiefs (ON)
12:00 PM	10	12	Florida Invest. Properties	2	7	15	Chicago Hitmen 70's (IL)
12:00 PM	5	12	Sacto. Islanders 70 (CA)	3	4	15	Midwest Express 70's (IA)
12:00 PM	9	5	Monkey Joe's Big Nut (NJ)	4	8	8	Chadwell Supply (FL)
1:30 PM	6	20	¥ Windsor Chiefs (ON)	1	10	21	Florida Invest. Properties
1:30 PM	7	20	Chicago Hitmen 70's (IL)	3	5	12	¥ Sacto. Islanders 70 (CA)

Sunday • February 10, 2019 • Loyce Harpe Park Softball Complex • Lakeland

Time	#	Runs	Team Name	Field	#	Runs	Team Name
9:00 AM	7	R	Chicago Hitmen 70's (IL)	1	8	O	Chadwell Supply (FL)
9:00 AM	10	A	Florida Invest. Properties	2	9	U	Monkey Joe's Big Nut (NJ)
10:30 AM	8	I	Chadwell Supply (FL)	1	10	T	Florida Invest. Properties
10:30 AM	9	N	Monkey Joe's Big Nut (NJ)	2	7	S	Chicago Hitmen 70's (IL)
12:00 PM	3	6	Lane Construction (FL)	1	4	13	Midwest Express 70's (IA)
12:00 PM	6	18	Windsor Chiefs (ON)	2	5	11	Sacto. Islanders 70 (CA)
1:30 PM	4	10	Midwest Express 70's (IA)	1	6	8	Windsor Chiefs (ON)
1:30 PM	5	1	Sacto. Islanders 70 (CA)	2	3	16	Lane Construction (FL)



SSUSA's Original Tournament of Champions 2019
Polk County, Florida
February 8 - 10, 2019

Rev. 01/29/2019

Men's 70/75/80+ Gold Division • 10 Teams

- | | | | |
|---|---------------------------|----|----------------------------|
| 1 | All-American (MN) | 6 | Windsor Chiefs (ON) |
| 2 | Florida Legends 75 | 7 | Chicago Hitmen 70's (IL) |
| 3 | Lane Construction (FL) | 8 | Chadwell Supply (FL) |
| 4 | Midwest Express 70's (IA) | 9 | Monkey Joe's Big Nut (NJ) |
| 5 | Sacto. Islanders 70 (CA) | 10 | Florida Invest. Properties |

EQUALIZERS

- § Teams #1-2 GIVE 5-Run equalizer and are HOME vs. Teams #3-6
- ¶ Teams #1-2 GIVE 7-Run equalizer and are HOME vs. Teams #7-10
- ¥ Teams #3-6 GIVE 5-Run equalizer and are HOME vs. Teams #7-10

Format: Mixed Round Robin format (six games minimum) • Champions determined as follows:

- Teams #1-2 play Best 2 of 3 Series for 70/75-Platinum championship
- Teams #3-6 play full (3-game) round robin, best record wins • INTERNAL SEEDING
- Teams #7-10 play full (3-game) round robin, best record wins • INTERNAL SEEDING

NOTE BOTH teams receive 1st place awards (trophy & rings)

NOTE Only games between teams #3-6 count in division round robin standings

NOTE Only games between teams #7-10 count in division round robin standings

Top finishing 75-AAA AND Teams #7 and #10 receive 1st place awards (trophy & rings)

Home Runs - Open

Pitch Count - Batters start with "0-0" count per SSUSA Rulebook §6.2 (Pitch Count)

Run Rules - Five (5) runs per ½ inning at bat (except open inning)

Time Limits - RR = 65 + open inn. • Bracket = 70 + open inn. • Championship game(s) = 7 innings full

Tie Breakers - Head to head (in full RR only), least runs allowed, run differential, coin toss

Schedule Subject to Change at Discretion of Tournament and Field Directors



SSUSA's Original Tournament of Champions 2019
Polk County, Florida
February 8 - 10, 2019

Rev. 01/29/2019

Men's 70/75+ Platinum Division • 2 Teams

Championship Bracket

SATURDAY

All American (15)

(1)

1:30 PM - #2

FL Legends (13)

SUNDAY

ALL AMERICAN

(2)

NO GAME
by
Mutual Consent

Loser Game 1

WINNER

OR Winner Game 2

(3)

NO GAME
(If Needed)

Loser Game 2, only
if 1st loss in Bracket

WINNER

Elimination Game



SSUSA's Original Tournament of Champions 2019

Polk County, Florida

February 8 - 10, 2019

Rev. 01/18/2019

Men's 80/85+ Gold Division • 5 Teams

<u>Win</u>	<u>Loss</u>	1	<u>80-AAA</u>	<u>Win</u>	<u>Loss</u>	4	<u>85-Major</u>
3	1	1	Chicago Geezers 80's (IL)	1	2	4	Center for Sight 85 (FL)
2	2	2	New York Statesmen	1	2	5	ProHealth Legends 85 (MN)
2	2	3	ProHealth Care (WI)				

Friday • February 8, 2019 • Southwest Softball Complex • Lakeland

Field address ► 1444 West Highlands Street • Lakeland, FL 33815

Time	#	Runs	Team Name	Field	#	Runs	Team Name
10:30 AM	5	20	ProHealth Legends 85 (MN)	1	2	12	New York Statesmen
12:00 PM	2	16	New York Statesmen	1	1	11	Chicago Geezers 80's (IL)
12:00 PM	4	9	Center for Sight 85 (FL)	2	3	15	ProHealth Care (WI)
1:30 PM	1	17	Chicago Geezers 80's (IL)	1	4	11	Center for Sight 85 (FL)
1:30 PM	3	12	ProHealth Care (WI)	2	5	10	ProHealth Legends 85 (MN)

Saturday • February 9, 2019 • Southwest Softball Complex • Lakeland

Time	#	Runs	Team Name	Field	#	Runs	Team Name
9:00 AM	4	29	Center for Sight 85 (FL)	2	2	18	New York Statesmen
9:00 AM	3	6	ProHealth Care (WI)	3	1	18	Chicago Geezers 80's (IL)
10:30 AM	1	22	Chicago Geezers 80's (IL)	2	5	21	ProHealth Legends 85 (MN)
10:30 AM	2	17	New York Statesmen	3	3	7	ProHealth Care (WI)

Format: Full (4-game) Round Robin to seed 80-AAA Championship playoffs
 Teams #1-3 Playoff • #2 and #3 seeds play Semi-Final, winner plays #1 seed • INTERNAL SEEDING
NOTE "If" game plays ONLY if UNBEATEN #1 Seed loses Championship Game #1
 Teams #4-5 play Best 2 of 3 Series for 85-Major Championship
 Home Runs - Open
 Pitch Count - Batters start with "0-0" count per SSUSA Rulebook §6.2 (Pitch Count)
 Time Limits - RR = 65 + open inn. • Bracket = 70 + open inn. • Championship game(s) = 7 innings full
 Tie Breakers - Head to head (in full RR only), least runs allowed, run differential, coin toss

Schedule Subject to Change at Discretion of Tournament and Field Directors



SSUSA's Original Tournament of Champions 2019
Polk County, Florida
February 8 - 10, 2019

Rev. 01/19/2019

Men's 80+ AAA Division • 3 Teams

Championship Playoff

ALL GAMES ON SUNDAY

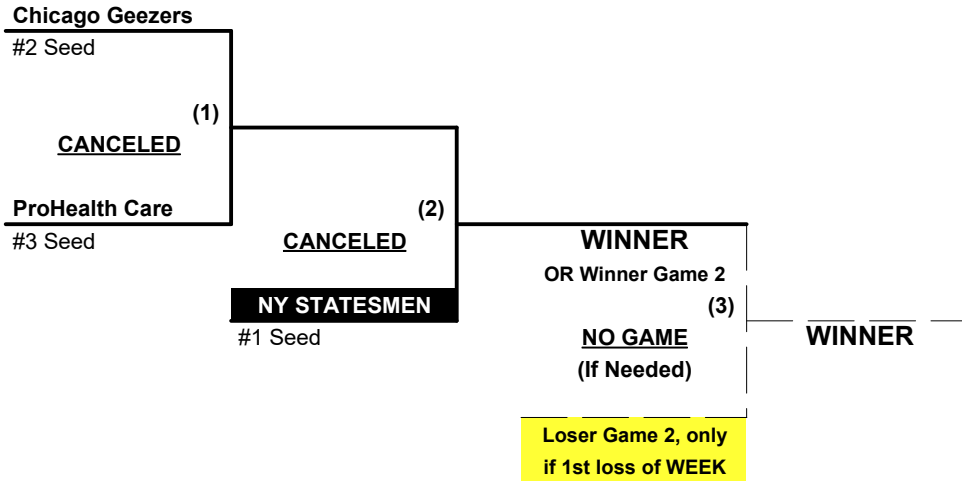

Men's 85+ Major Division • 2 Teams

Championship Bracket

SATURDAY

SUNDAY

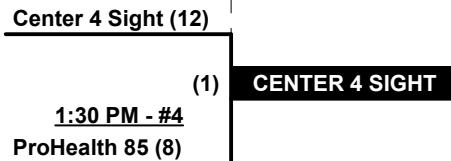

Elimination Game

